

320E

Hydraulic Excavator



Engine

Engine Model	Cat® C6.6 ACERT™
Net Power – ISO 9249 (metric)	114 kW (155 hp)

Drive

Maximum Travel Speed	5.6 km/h
Maximum Drawbar Pull	205 kN

Weights

320E L:	
Minimum Weight	21 700 kg
Maximum Weight	23 500 kg
320E LN:	
Minimum Weight	22 100 kg
Maximum Weight	23 640 kg

Introduction

Since its introduction in the 1990s, the 300 Series family of excavators has become the industry standard in general, quarry, and heavy construction applications. The all-new E Series and the 320E will continue that trend-setting standard.

The 320E meets today's European Union emission standards. It is also built with several new fuel-saving and comfort-enabling features and benefits that will delight owners and operators.

If you are looking for more productivity and comfort less fuel consumption and emissions, and easier and more sensible serviceability, you will find it in the all-new 320E and the E Series family of excavators.



Contents

Engine	3
Operator Station.....	4
Hydraulics	5
Structures & Undercarriage	6
Front Linkage	7
Work Tools.....	8
Integrated Technologies.....	10
Serviceability.....	11
Safety	12
Complete Customer Care.....	13
Sustainability	14
Specifications.....	15
Standard Equipment.....	33
Optional Equipment.....	34

Engine

Reduced emissions, economical and reliable performance

Cat® C6.6 ACERT™ Engine

The Cat C6.6 ACERT engine delivers more horsepower using significantly less fuel than the previous series engine.

Emissions Solution

Equipped to meet Stage IIIB emissions standards, the 320E's C6.6 ACERT engine features wall and thru flow filters that perform through the machine work cycle without operator intervention.

All nonroad European Union Stage IIIB diesel engines are required to use only Ultra Low Sulfur Diesel (ULSD) fuels containing 15 mg/kg sulfur or less. Cat® DEO-ULS™ or oils that meet the Cat ECF-3, API CJ-4, and ACEA E9 specification are also required. For further fluid specifications and guidelines, visit: <http://www.cat.com/cdal/files/214956/71/SEBU6251-13-secured.pdf>

Biodiesel-Ready Fuel System

The C6.6 ACERT engine is equipped with an electronic-controlled high-pressure fuel system that includes an electric priming pump (lifting pump) and three-layer fuel hoses to allow the use of biodiesels up to B20 (biodiesel fuel 20% mixture meeting ASTM 6751 or EN 14214).

Cooling System

The cooling system features an air-to-air aftercooler and A/C condenser that tilt up and swing out of the way for easy servicing; the fan automatically adjusts to ambient temperatures to help reduce fuel consumption and noise.

Speed and Power Control

The 320E features speed control to maintain a constant speed – regardless of load – to improve fuel economy. Two different power modes are offered: high power and economy. The operator can easily change between modes through the monitor or console switch to meet the needs for the job at hand – all to help manage and conserve fuel.



Operator Station

Comfort and convenience to keep people productive



Seats

The seat range includes air suspension and heating options. All seats include a reclining back, upper and lower seat slide adjustments, and height and tilt angle adjustments to meet operator needs for comfort and productivity.

Controls

The right and left joystick consoles can be adjusted to meet individual preferences, improving operator comfort and productivity during the course of a day. With the touch of a button, one-touch idle reduces engine speed to help save fuel; touch it again or move the joystick and the machine returns to normal operating level. The heavy lift mode increases machine system pressure to improve lift applications.

Monitor

The 320E is equipped with a 7" LCD (Liquid Crystal Display) monitor that's 40% bigger than the previous model's with higher resolution for better visibility. In addition to an improved keypad and added functionality, it's programmable to provide information in a choice of 42 languages to support today's diverse workforce.

An "Engine Shutdown Setting" accessible through the monitor allows owners and operators to specify how long the machine should idle before shutting down the engine, which can save significant amounts of fuel. The image of the rearview camera is displayed directly on the monitor. Up to two different camera images can be displayed on the screen at the same time.

Power Supply

Two 12-volt power supply sockets are located near key storage areas for charging electronic devices.

Storage

Storage spaces are located in the front, rear, and side consoles. A specific space near the auxiliary power supply holds MP3 players and cell phones. The drink holder accommodates large mugs with handles, and a shelf behind the seat stores large lunch or toolboxes.

Automatic Climate Control

The climate control system features five air outlets with positive filtered ventilation, which makes working in the heat and cold much more pleasant.





Hydraulics

Power to move more dirt, rock, and debris with speed and precision

Main Control Valve and Auxiliary Valves

The 320E uses a high-pressure system to tackle the toughest of work in short order. The machine features a highly efficient and simple back-to-back main control valve to improve fuel consumption; it also allows for greater tool versatility.

Swing Priority Circuit

The swing priority circuit on the 320E uses an electric valve that's operated by the machine's Electronic Control Module (ECM). Compared to using a hydraulic valve, an electric valve allows for more finely tuned control, which is critical during material loading.

SmartBoom™

SmartBoom reduces stress and vibrations transmitted to the machine and provides a more comfortable environment. It is particularly well suited for certain applications:

- **Rock scraping.** SmartBoom simplifies the task and allows the operator to concentrate on stick and bucket while the boom freely goes up and down without using pump flow.
- **Hammer work.** The front parts automatically follow the hammer while penetrating the rock. Blank shots or excessive force on the hammer are avoided, resulting in longer life for the hammer and the machine.

Electric Boom Regeneration Valve

This valve minimizes pump flow when the boom lowers down, which helps improve fuel efficiency. It is optimized for any dial speed setting being used by the operator, which results in optimized boom lowering speed for higher controllability.



Structures & Undercarriage

Built to work in rugged environments

Frame

The upper frame includes reinforced mountings to support the Roll-Over Protective Structure (ROPS) cab; the lower frame is reinforced to increase component durability.

Undercarriage

Fixed gauge long and long narrow undercarriage systems are available to support various work applications.

A segmented two-piece guiding guard is now offered to help maintain track alignment and improve performance in multiple applications.

Counterweights

Three counterweight options are available: 3.55 mt (L), 4.1 mt (LN) and 4.6 mt (SLR). All feature an integrated rearview camera housing and integrated links to enable easy removal for maintenance or shipping.

Front Linkage

Made for high stress and long service life

Booms and Sticks

The 320E is offered with a range of booms and sticks. Each is built with internal baffle plates for added durability, and each undergoes ultrasound inspection to ensure weld quality and reliability.

Large box-section structures with thick, multi-plate fabrications, castings, and forgings are used in high-stress areas such as the boom nose, boom foot, boom cylinder, and stick foot to improve durability.

The boom nose pin retention method is a durable captured flag design. Boom durability is improved with a number of plate thickness changes. Also, the front linkage pins' inner bearing surfaces are welded, and a self-lubricated bearing is used to extend service intervals and increase uptime.

Selections

There are three basic boom options: Reach, SLR, and VA. Sticks match the boom descriptions and applications below:

- **Reach** – This boom is designed to balance reach, digging force, and bucket capacity. It covers the vast majority of applications such as digging, loading, trenching, and working with hydraulic tools. The 320E LN is equipped with a Heavy Duty Reach boom.
- **SLR = Super Long Reach** – This configuration offers reaches to over 15 m. It is well suited for ditch cleaning applications. Available on the 320E L only.
- **VA = Variable Angle** – This configuration offers superb flexibility and versatility in the working envelope. Boom position can be adjusted from 90° when fully retracted to 180° and fully extended. With full extension, the working range gives maximum dig depth, reach, and working height. Equally, when retracted, it can work closer to its tracks, increase lifting capacity, and work in confined areas.



Work Tools

Dig, hammer, rip, and cut with confidence



An extensive range of Cat Work Tools for the 320E includes buckets, compactors, grapples, multi-processors, scrap and demolition shears, rippers, crushers, pulverizers, hammers, and shears. Each is designed to optimize the versatility and performance of your machine.

CW Quick Couplers

Quick couplers allow one person to change work tools in seconds for maximum performance and flexibility on a job site. One machine can move rapidly from task to task, and a fleet of similarly equipped machines can share a common work tool inventory. The dedicated CW Series quick coupler enables a quick tool exchange while maintaining top machine performance. A lifting hook is added for maximum lift capacity.

The CW quick coupler can pick up any work tool and is equipped with a wedge-style locking system that fits the quick coupler tight to the tool hinges. Due to the tapered wedge design, there won't be any play during its entire life. Also, it is interchangeable with different machine classes. The CW is highly suitable for harsh applications such as demolition and quarries.

Buckets

Cat buckets are designed as an integral part of the 320E system and feature new geometry for better performance. The leading edge has been pushed forward, resulting in more efficient filling and better operator control for greatly improved productivity. Wear coverage in the corners and side cutter and sidebar protector coverage are improved. All benefits are captured in a new bucket line with a new bucket naming convention.

Durability Categories Suitable for Any Situation

For the 320E excavator, Caterpillar offers three standard bucket categories for excavators. Each category is based on intended bucket durability when used in recommended application and material. Each bucket durability is available as pin-on or can be used with a Quick Coupler. Red areas on bucket images illustrate additional protection against wear as it increases across each category.

General Duty (GD)

GD buckets are for digging in low-impact, low-abrasion material such as dirt, loam, and mixed compositions of dirt and fine gravel.

Heavy Duty (HD)

The most popular bucket style, HD buckets are a good starting point when digging conditions are not well known like a wide range of impact and abrasion conditions that include mixed dirt, clay, and rock.

Severe Duty (SD)

SD buckets are for higher abrasion conditions such as well shot granite and caliche.

Special Buckets

Special buckets are available for the 320E on request.

Comprehensive Product Support

All Cat Work Tools are backed up by a world-wide network of well-stocked parts depots and highly experienced service and support personnel.

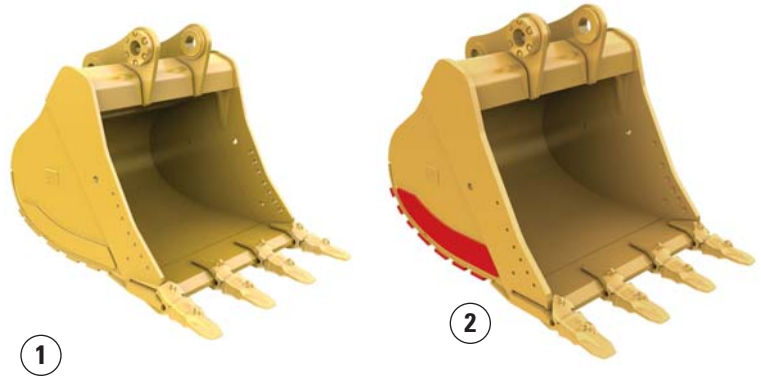

1

2

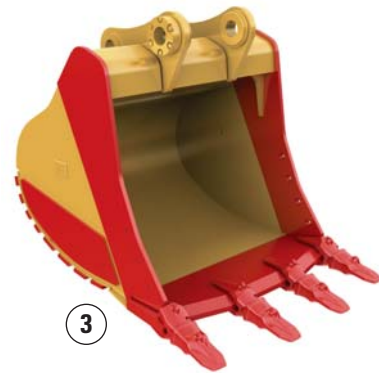

3

1) General Duty 2) Heavy Duty 3) Severe Duty



Integrated Technologies

Solutions that make work easier and more efficient

Cat® Grade Control Depth and Slope

This optional system combines traditional machine control and guidance with standard factory-installed and calibrated components, making the system ready to go to work the moment it leaves the factory. The system utilizes internal front linkage sensors – well protected from the harsh working environment – to give operators real-time bucket tip position information through the cab monitor (1), which minimizes the need and cost for traditional grade checking and improves job site safety. It also helps the operator complete jobs in fewer cycles, which means less fuel use. Cat dealers can upgrade the system to full three-dimensional control by adding proven Cat AccuGrade™ positioning technologies, including GPS and Universal Total Station (UTS).

Cat Product Link

This deeply integrated machine monitoring system (2 and 3) is designed to help customers improve their overall fleet management effectiveness. Events and diagnostic codes as well as hours, fuel consumption, idle time, machine location, and other detailed information are transmitted to a secure web based application called VisionLink™, which uses powerful tools to communicate to users and dealers.

Serviceability

Fast, easy and safe access built in

Service Doors

Wide service doors and a one-piece hood provide easy access to the engine and cooling compartments. Both doors and hood feature enhanced hardware and a new screen design to help minimize debris entry.

Compartments

The radiator, pump, and air cleaner compartments provide easy access to major components. The fresh air filter is located on the side of the cab to make it easy to reach and replace as needed.

Maintenance

Tilt-up ATAAC and swing out A/C condenser for easy cleaning.

Other Service Benefits

The water separator with water level sensor has a primary fuel filter element located in the pump compartment near ground level; the electric priming pump (lifting pump) is mounted before the primary filter base and is easy to service compared to a traditional hand-priming pump.

The fuel tank features a remote drain cock located in the pump compartment to make it easy to remove water and sediment during maintenance.

The engine oil check gauge is situated in front of the engine compartment for easy access, and a uniquely designed drain cock helps prevent spills. The engine oil filter is located in the pump compartment. The hydraulic valve lush on the engine valve does not need maintenance.

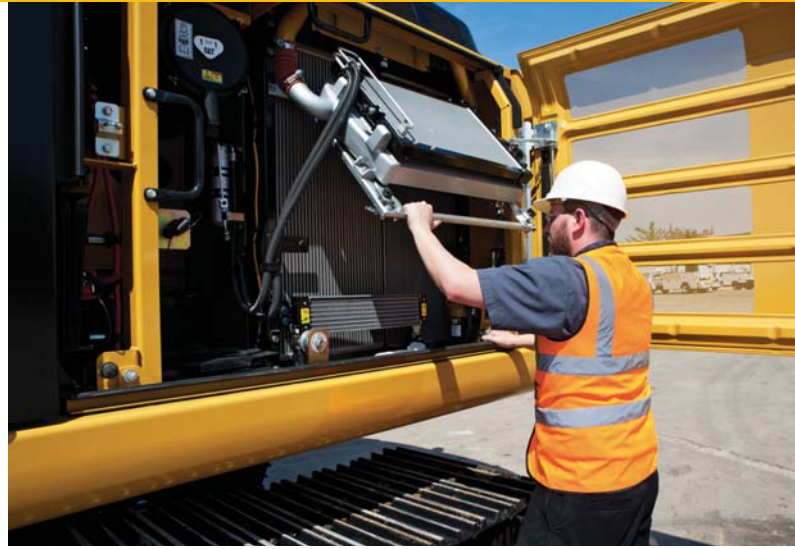

Safety

Features to help protect people

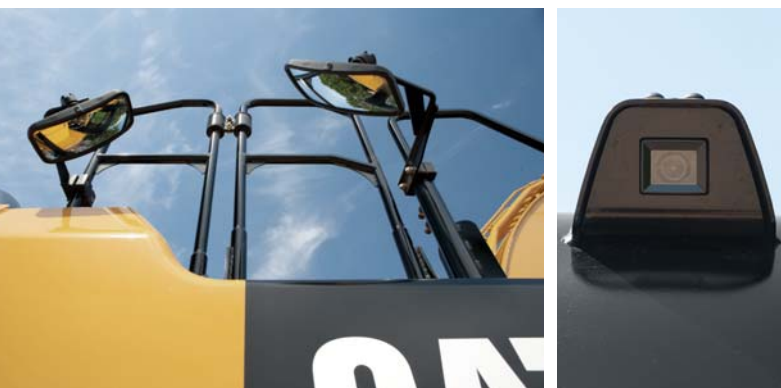

ROPS Cab (ISO 12117)

The ROPS-certified cab allows a Falling Object Guard Structure (FOGS) to be bolted directly to it.

Sound Proofing

Improved sealing and cab roof lining lower noise levels inside the cab significantly during machine operation (-5 dB).

Anti-Skid Plates

The surface of the upper structure and the top of the storage box area are covered with anti-skid plates to help prevent service personnel and operators from slipping during maintenance.

Steps, Hand and Guard Rails (ISO 2867)

Steps on the track frame and storage box along with extended hand and guard rails (2) to the upper deck enable operators to securely work on the machine.

Time Delay Lights

After the engine start key has been turned to the “OFF” position, cab and boom lights will illuminate to enhance visibility. The time delay can vary from 0 to 90 seconds, which can be set through the monitor.

High Intensity Discharge (HID) Lights

Halogen lights are standard, but they can be upgraded to HID for greater visibility.

Windows

The 70/30 split windshield features an upper window equipped with handles on the top and both sides so the operator can slide it to store in the ceiling. The lower window is removable and can be stored on the left wall of the cab shell.

The large skylight provides great overhead visibility, excellent natural lighting, and good ventilation. The skylight can be opened completely to become an emergency exit.

Monitor Warning System

The monitor is equipped with a buzzer that can warn operators of critical events so they can take any necessary action.

Rearview Camera and Mirrors (ISO 5006)

The standard rearview camera is housed in the counterweight. The image projects through the cab monitor to give the operator a clear view of what is behind the machine. The mirrors and rearview camera are designed to meet the visibility regulations.



Complete Customer Care

Service you can count on

Product Support

Cat dealers utilize a worldwide parts network to maximize your machines' uptime. Plus they can help you save money with Cat remanufactured components.

Machine Selection

What are the job requirements and machine attachments? What production is needed? Your Cat dealer can provide recommendations to help you make the right machine choices.

Purchase

Consider financing options and day-to-day operating costs. Look at dealer services that can be included in the machine's cost to yield lower owning and operating costs over time.

Customer Support Agreements

Cat dealers offer a variety of customer support agreements and work with you to develop a plan to meet your specific needs. These plans can cover the entire machine, including attachments, to help protect your investment.

Operation

Improving operating techniques can boost your profits. Your Cat dealer has videos, literature, and other ideas to help you increase productivity. Caterpillar also offers simulators and certified operator training to help maximize the return on your investment.

Replacement

Repair, rebuild, or replace? Your Cat dealer can help you evaluate the cost involved so you can make the best choice for your business.



Sustainability

Generations ahead in every way

- The C6.6 ACERT engine, along with the Cat Clean Emissions Module (CEM), meets EU Stage IIIB emission standards.
- Even when operating in high horsepower and high production applications, the 320E performs a similar amount of work while burning up to 12% less fuel than the previous D Series model. This means more efficiency, less resources consumed, and fewer CO₂ emissions.
- The 320E has the flexibility of running on either ultra-low-sulfur diesel (ULSD) fuel with 15 mg/kg of sulfur or less or biodiesel (B20) fuel blended with ULSD.
- A ground-level overfill indicator rises when the hydraulic oil tank is full to help the operator avoid spilling.
- The QuickEvac™ feature ensures fast, easy, and secure changing of engine and hydraulic oil (320E L only).
- The 320E is built to be rebuilt with major structures and components capable of being remanufactured to reduce waste and replacement costs.
- An engine oil filter is designed so that it eliminates the need for painted metal cans and aluminum top plates. The cartridge-style spin-on housing enables the internal filter to be separated and replaced.
- The 320E is an efficient, productive machine that's designed to conserve our natural resources for generations ahead.

320E Hydraulic Excavator Specifications

Engine

Engine Model	Cat® C6.6 ACERT™
Power – ISO 14396	112 kW
Power – ISO 14396 (metric)	152 hp
Power – ISO 14396 (imperial)	150 hp
Net Power – ISO 9249 (metric)	114 kW
Net Power – ISO 9249 (metric)	155 hp
Net Power – ISO 9249 (imperial)	152 hp
Bore	105 mm
Stroke	127 mm
Displacement	6.6 L

Weights

320E L:	
Minimum Weight	21 700 kg
Maximum Weight	23 500 kg
320E LN:	
Minimum Weight	22 100 kg
Maximum Weight	23 640 kg

Hydraulic System

Main System – Maximum Flow (Total)	428 L/min
Swing System – Maximum Flow (x2)	214 L/min
Maximum Pressure – Equipment	35 000/38 000 kPa
Maximum Pressure – Travel	35 000 kPa
Maximum Pressure – Swing	25 000 kPa
Pilot System – Maximum Flow	24.3 L/min
Pilot System – Maximum Pressure	3920 kPa
Boom Cylinder – Bore	120 mm
Boom Cylinder – Stroke	1260 mm
Stick Cylinder – Bore	140 mm
Stick Cylinder – Stroke	1504 mm
B1 Bucket Cylinder – Bore	120 mm
B1 Bucket Cylinder – Stroke	1104 mm

Drive

Maximum Travel Speed	5.6 km/h
Maximum Drawbar Pull	205 kN

Swing Mechanism

Swing Speed	11.2 rpm
Swing Torque	61.8 kN·m

Service Refill Capacities (320E L)

Fuel Tank Capacity	410 L
Cooling System	30 L
Engine Oil (with filter)	23 L
Swing Drive	8 L
Final Drive (each)	8 L
Hydraulic System (including tank)	260 L
Hydraulic Tank	159 L

Service Refill Capacities (320E LN)

Fuel Tank Capacity	310 L
Cooling System	30 L
Engine Oil (with filter)	23 L
Swing Drive (each)	8 L
Final Drive (each)	8 L
Hydraulic System Oil Capacity (including tank)	260 L
Hydraulic Tank Oil	153 L

Track

Number of Shoes (each side)	
Long/Long Narrow Undercarriage	49 pieces
Number of Track Rollers (each side)	
Long/Long Narrow Undercarriage	8 pieces
Number of Carrier Rollers (each side)	
Long/Long Narrow Undercarriage	2 pieces

Sound Performance

ISO 6396	
Operator Sound	71 dB(A)
ISO 6395	
Spectator Sound	103 dB(A)

- Operator Sound – The operator sound level is measured according to the procedures specified in ISO 6394:1998, for cab offered by Caterpillar, when properly installed and maintained and tested with doors and windows closed.
- Exterior Sound – The labeled spectator sound power level is measured according to the test procedures and conditions specified in 2004/14/EC.
- Hearing protection may be needed when operating with an open operator station and cab (when not properly maintained for doors/windows open) for extended periods or in a noisy environment.

Standards

Brakes	ISO 10265 2008
Cab/FOGS	ISO 10262 1998
Cab/ROPS	ISO 12117-2 2008

320E Hydraulic Excavator Specifications

320E L Dimensions

All dimensions are approximate.

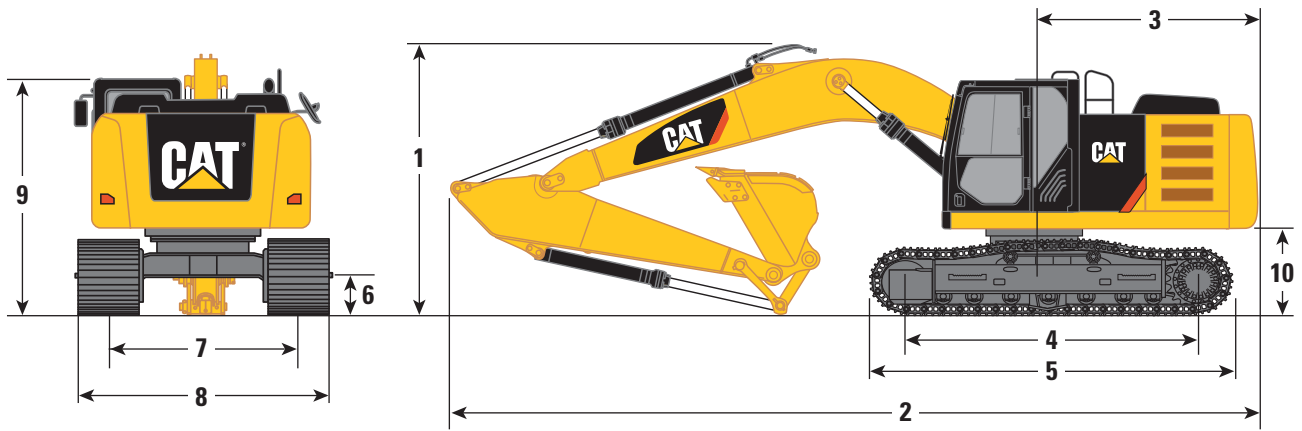

Stick	Reach Boom 5.7 m		Super Long Reach Boom 8.85 m	VA Boom	
	R2.9B1	R2.5B1	Super Long Reach 6.28 m	R2.9B1	R2.5B1
1 Shipping Height without Guard Rail*	3130 mm	3050 mm	3210 mm	2970 mm	3020 mm
Shipping Height with Guard Rail	3240 mm	3240 mm	3240 mm	3240 mm	3240 mm
Shipping Height with Top Guard, without Guard Rail	3150 mm	3150 mm	3150 mm	3150 mm	3150 mm
2 Shipping Length	9540 mm	9450 mm	12 750 mm	9780 mm	9820 mm
3 Tail Swing Radius	2830 mm	2830 mm	2830 mm	2830 mm	2830 mm
4 Length to Center of Rollers	3650 mm	3650 mm	3650 mm	3650 mm	3650 mm
5 Track Length	4460 mm	4460 mm	4460 mm	4460 mm	4460 mm
6 Ground Clearance	450 mm	450 mm	450 mm	450 mm	450 mm
7 Track Gauge	2380 mm	2380 mm	2380 mm	2380 mm	2380 mm
8 Transport Width					
600 mm Shoes	2980 mm	2980 mm	2980 mm	2980 mm	2980 mm
700 mm Shoes	3080 mm	3080 mm	3080 mm	3080 mm	3080 mm
790 mm Shoes	3170 mm	3170 mm	3170 mm	3170 mm	3170 mm
9 Cab Height	2960 mm	2960 mm	2960 mm	2960 mm	2960 mm
Cab Height with Top Guard	3150 mm	3150 mm	3150 mm	3150 mm	3150 mm
10 Counterweight Clearance**	1020 mm	1020 mm	1020 mm	1020 mm	1020 mm
Bucket Capacity	1.3 m ³	1.3 m ³	0.28 m ³	1.3 m ³	1.3 m ³
Bucket Tip Radius	1560 mm	1560 mm	1070 mm	1560 mm	1560 mm

*Including shoe lug height.

**Without shoe lug height.

320E LN Dimensions

All dimensions are approximate.

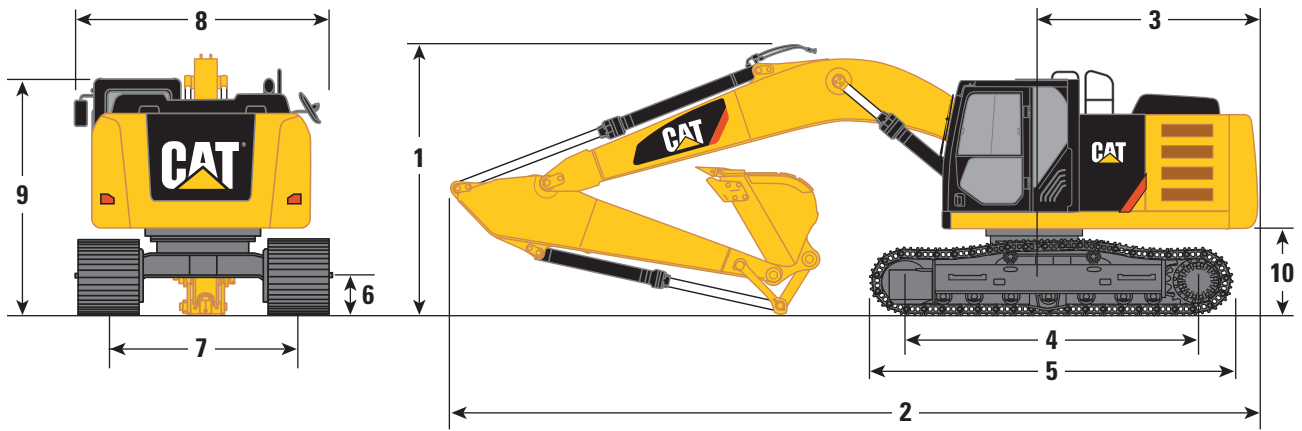

	Reach Boom 5.7 m		VA Boom
Stick	R2.5B1	R1.9CB2	R2.5B1
1 Shipping Height without Guard Rail*	3080 mm	3050 mm	3020 mm
Shipping Height with Guard Rail	3240 mm	3240 mm	3240 mm
Shipping Height with Top Guard, without Guard Rail	3150 mm	3150 mm	3150 mm
2 Shipping Length	9570 mm	9460 mm	9820 mm
3 Tail Swing Radius	2830 mm	2830 mm	2830 mm
4 Length to Center of Rollers	3650 mm	3650 mm	3650 mm
5 Track Length	4460 mm	4460 mm	4460 mm
6 Ground Clearance	450 mm	450 mm	450 mm
7 Track Gauge	2000 mm	2000 mm	2000 mm
8 Transport Width			
500 mm Shoes	2540 mm	2540 mm	2540 mm
9 Cab Height	2960 mm	2960 mm	2960 mm
Cab Height with Top Guard	3150 mm	3150 mm	3150 mm
10 Counterweight Clearance**	1020 mm	1020 mm	1020 mm
Bucket Capacity	1.3 m ³	1.3 m ³	1.3 m ³
Bucket Tip Radius	1560 mm	1620 mm	1560 mm

*Including shoe lug height.

**Without shoe lug height.

320E Hydraulic Excavator Specifications

320E L Working Ranges

All dimensions are approximate.

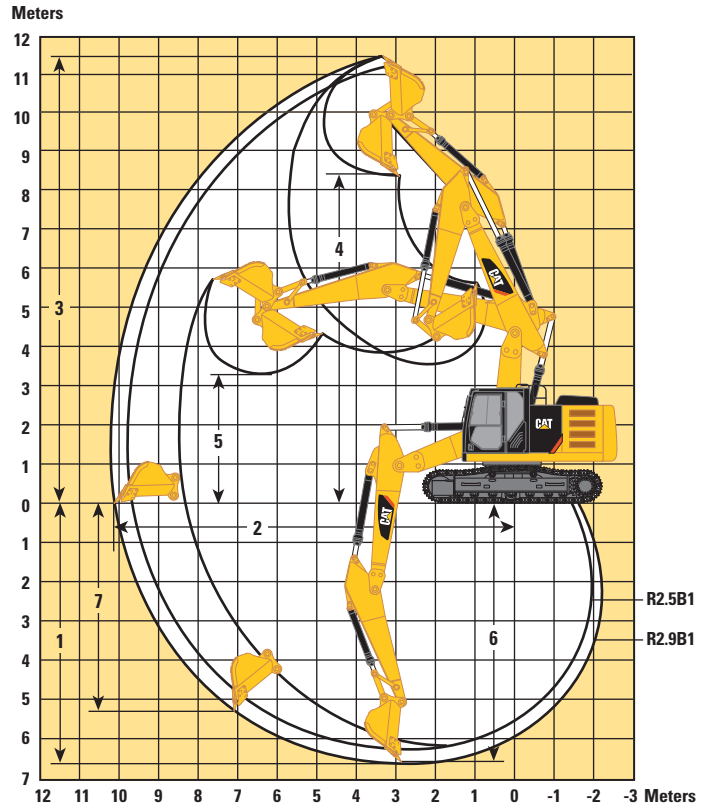
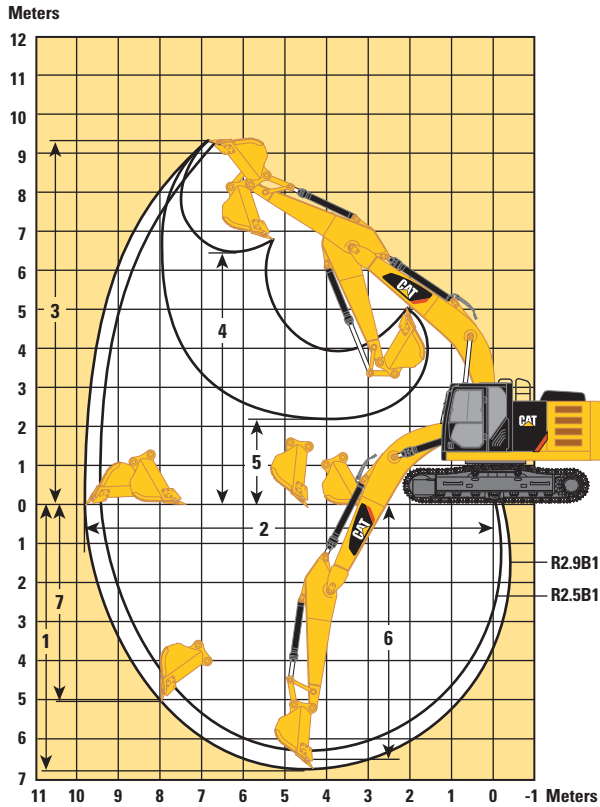

**Reach Boom
5.7 m**

VA Boom

Stick	Reach Boom 5.7 m		VA Boom	
	R2.9B1	R2.5B1	R2.9B1	R2.5B1
Maximum Slope	35°/70%	35°/70%	35°/70%	35°/70%
1 Maximum Digging Depth	6720 mm	6290 mm	6680 mm	6270 mm
2 Maximum Reach at Ground Level	9860 mm	9450 mm	10 200 mm	9800 mm
3 Maximum Cutting Height	9370 mm	9240 mm	11 520 mm	11 180 mm
4 Maximum Loading Height	6490 mm	6300 mm	8410 mm	8070 mm
5 Minimum Loading Height	2170 mm	2600 mm	3270 mm	3670 mm
6 Maximum Depth Cut for 2440 mm Level Bottom	6550 mm	6100 mm	6580 mm	6170 mm
7 Maximum Vertical Wall Digging Depth	5060 mm	5210 mm	5290 mm	4890 mm
Bucket Capacity	1.19 m ³	1.3 m ³	1.3 m ³	1.3 m ³
Bucket Tip Radius	1570 mm	1560 mm	1560 mm	1560 mm

320E L Working Ranges

All dimensions are approximate.

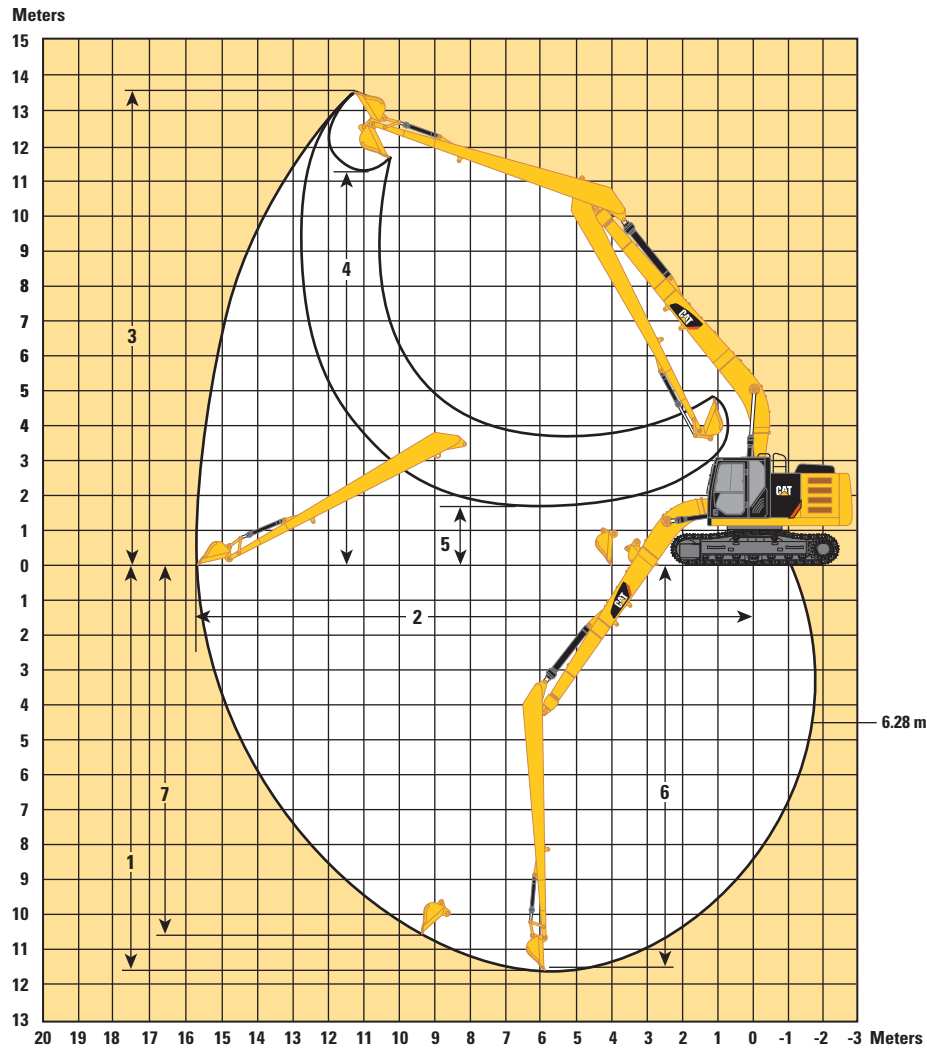

**Super Long Reach Boom
8.85 m**

**Super Long Reach Stick
6.28 m**

Maximum Slope

35°/70%

1 Maximum Digging Depth

11 690 mm

2 Maximum Reach at Ground Level

15 720 mm

3 Maximum Cutting Height

13 590 mm

4 Maximum Loading Height

11 290 mm

5 Minimum Loading Height

1740 mm

6 Maximum Depth Cut for 2440 mm Level Bottom

11 590 mm

7 Maximum Vertical Wall Digging Depth

10 670 mm

Bucket Capacity

0.28 m³

Bucket Tip Radius

1070 mm

320E Hydraulic Excavator Specifications

320E LN Working Ranges

All dimensions are approximate.

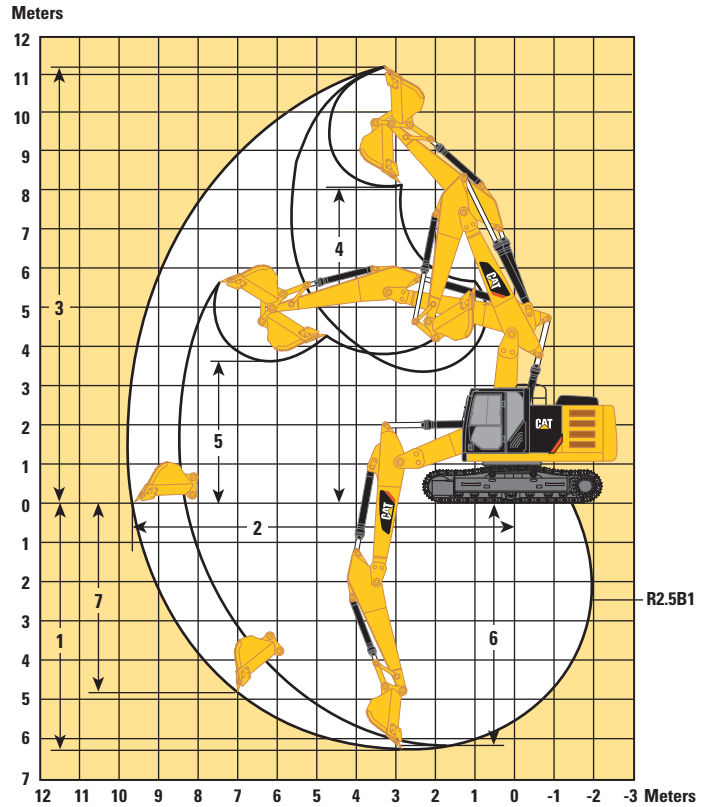
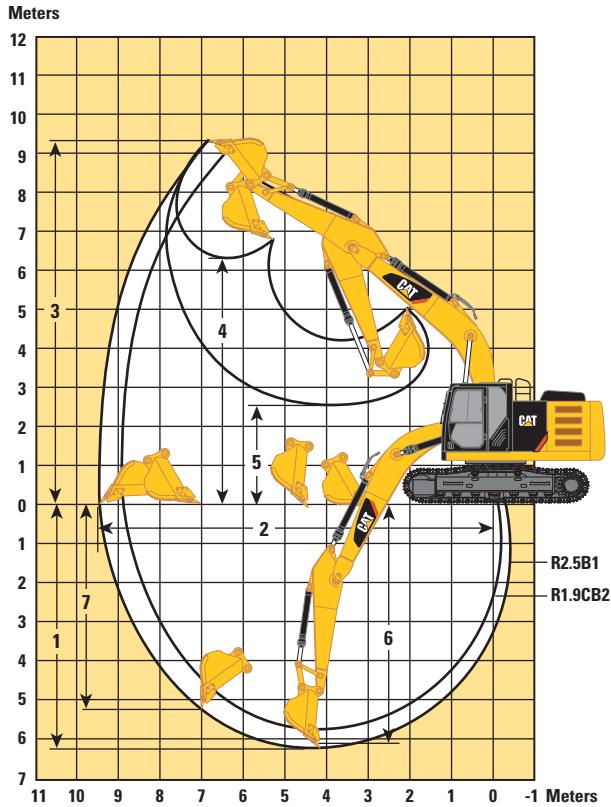

Stick	Reach Boom 5.7 m		VA Boom
	R2.5B1	R1.9CB2	R2.5B1
Maximum Slope	35°/70%	35°/70%	35°/70%
1 Maximum Digging Depth	6290 mm	5760 mm	6270 mm
2 Maximum Reach at Ground Level	9450 mm	8950 mm	9800 mm
3 Maximum Cutting Height	9240 mm	8940 mm	11 180 mm
4 Maximum Loading Height	6300 mm	5930 mm	8070 mm
5 Minimum Loading Height	2600 mm	3150 mm	3670 mm
6 Maximum Depth Cut for 2440 mm Level Bottom	6100 mm	5520 mm	6170 mm
7 Maximum Vertical Wall Digging Depth	5210 mm	4360 mm	4890 mm
Bucket Capacity	1.3 m ³	1.3 m ³	1.3 m ³
Bucket Tip Radius	1557 mm	1622 mm	1557 mm

320E L Operating Weight and Ground Pressure*

	790 mm Triple Grouser Shoes		700 mm Triple Grouser Shoes		600 mm Triple Grouser Shoes	
	kg	kPa	kg	kPa	kg	kPa
Reach Boom – 5.7 m						
R2.9B1 HD	22 200	35.1	21 900	39.1	21 600	44.9
R2.5B1 HD	22 100	34.9	21 800	38.8	21 400	44.5
VA Boom						
R2.9 ES	23 600	37.2	23 300	41.5	23 000	47.8
R2.5 HD	23 200	36.6	22 900	40.8	22 600	46.9
Super Long Reach Boom – 8.85 m						
6.28 m (SLR)	23 500	37.1	23 200	41.3	22 800	47.4

*Actual weights will depend on final machine configuration.

320E L Major Component Weights

	kg
Base Machine (with boom cylinder, without counterweight, front linkage and track)	11 300
Long Undercarriage	7850
Counterweight	
3.55 mt	3550
4.60 mt (Super Long Reach counterweight)	4600
Boom (includes lines, pins and stick cylinder)	
Reach Boom – 5.7 m	1670
VA Boom	2580
Super Long Reach – 8.85 m	2400
Stick (includes lines, pins and bucket cylinder)	
R2.9B1 HD	680
R2.5B1 HD	670
6.28 m (SLR)	1240
Track Shoe (Long/per two tracks)	
600 mm Triple Grouser	2700
700 mm Triple Grouser	3070
790 mm Triple Grouser	3360

All weights are rounded up to nearest 10 kg except for buckets. Kg was rounded up separately so some of the kg do not match.

Base machine includes 75 kg operator weight, 90% fuel weight, and undercarriage with center guard.

320E Hydraulic Excavator Specifications

320E LN Operating Weight and Ground Pressure*

	600 mm Triple Grouser Shoes	
	kg	kPa
HD Reach Boom – 5.7 m		
R2.5B1 ES	22 460	66.7
R1.9CB2 HD	22 480	66.7
VA Boom		
R2.5B1 ES	23 640	69.8

*Actual weights will depend on final machine configuration.

320E LN Major Component Weights

	kg
Base Machine (with boom cylinder, without counterweight, front linkage and track)	11 450
Long Narrow Undercarriage with 500 mm Triple Grouser	6880
Counterweight	
4.1 mt	4100
Boom (includes lines, pins and stick cylinder)	
Reach Boom – 5.7 m	1430
VA Boom	2310
Stick (includes lines, pins and bucket cylinder)	
R2.5B1 ES	750
R1.9CB2 HD	750
Track Shoe (Long/per two tracks)	
500 mm Triple Grouser	2440

All weights are rounded up to nearest 10 kg except for buckets. Kg was rounded up separately so some of the kg do not match.

Base machine includes 75 kg operator weight, 90% fuel weight, and undercarriage with center guard.

320E L/320E LN Bucket and Stick Forces

Stick	VA Boom			320E L Super Long Reach Boom 8.85 m		
	without CW	for CW-40	for CW-40S	A1-Family Bucket Super Long Reach 6.28 m		
	R2.5B1 kN	R2.5B1 kN	R2.5B1 kN	kN		
General Duty						
Bucket Digging Force (ISO)	140.5	127.7	127.7	45.5		
Stick Digging Force (ISO)	118.2	114.0	114.0	35.4		
General Duty Capacity						
Bucket Digging Force (ISO)	139.4	–	–	–		
Stick Digging Force (ISO)	117.7	–	–	–		
Heavy Duty						
Bucket Digging Force (ISO)	140.2	127.4	127.4	–		
Stick Digging Force (ISO)	118.1	113.8	113.8	–		

Stick	Reach Boom 5.7 m								
	without CW			for CW-40			for CW-40S		
	R2.9B1 kN	R2.5B1 ¹ kN	R1.9CB2 ² kN	R2.9B1 kN	R2.5B1 ¹ kN	R1.9CB2 ² kN	R2.9B1 kN	R2.5B1 ¹ kN	R1.9CB2 ² kN
General Duty									
Bucket Digging Force (ISO)	140.5	140.5	178.9	127.7	127.7	162.87	127.7	127.7	–
Stick Digging Force (ISO)	106.7	118.2	147.9	103.2	114.0	140.6	103.2	114.0	–
General Duty Capacity									
Bucket Digging Force (ISO)	139.4	139.4	174.1	–	–	–	–	–	–
Stick Digging Force (ISO)	106.2	117.7	145.5	–	–	–	–	–	–
Heavy Duty									
Bucket Digging Force (ISO)	140.2	140.2	178.7	127.4	127.4	–	127.4	127.4	171.78
Stick Digging Force (ISO)	106.6	118.1	147.8	103.1	113.8	–	103.1	113.8	144.78
Heavy Duty Power									
Bucket Digging Force (ISO)	–	–	194.9	–	–	–	–	–	–
Stick Digging Force (ISO)	–	–	149.7	–	–	–	–	–	–
Severe Duty									
Bucket Digging Force (ISO)	–	–	178.5	–	–	–	–	–	–
Stick Digging Force (ISO)	–	–	147.7	–	–	–	–	–	–

¹B1-Family Bucket

²CB2-Family Bucket

320E Hydraulic Excavator Specifications

320E L Reach Boom Lift Capacities



Load Point Height



Load at Maximum Reach



Load Radius Over Front



Load Radius Over Side

Boom – 5.7 m
Stick – R2.5B1

Counterweight – 3.55 mt
Shoes – 600 mm triple grouser

Bucket – None
Heavy Lift – On

Load Point Height	kg	3.0 m		4.5 m		6.0 m		7.5 m		m		
		Front	Side	Front	Side	Front	Side	Front	Side	Front	Side	
7.5 m	kg									*5150	*5150	5.59
6.0 m	kg					*5900	5200			*4750	4200	6.83
4.5 m	kg			*7450	*7450	*6400	5050	*5200	3600	*4650	3500	7.57
3.0 m	kg			*9350	7350	*7250	4850	5450	3500	*4750	3200	7.96
1.5 m	kg			*11 050	6900	7450	4650	5350	3400	4800	3100	8.05
Ground Line	kg			11 450	6700	7250	4500	5250	3350	4950	3150	7.86
-1.5 m	kg	*12 000	*12 000	11 400	6650	7200	4450			5400	3450	7.35
-3.0 m	kg	*14 650	13 000	*10 650	6750	7300	4500			6550	4100	6.46
-4.5 m	kg			*7950	7000					*6900	6100	4.98

Boom – 5.7 m
Stick – R2.9B1

Counterweight – 3.55 mt
Shoes – 700 mm triple grouser

Bucket – None
Heavy Lift – On

Load Point Height	kg	1.5 m		3.0 m		4.5 m		6.0 m		7.5 m		m		
		Front	Side	Front	Side	Front	Side	Front	Side	Front	Side	Front	Side	
7.5 m	kg							*4950	*4950			*4300	*4300	6.15
6.0 m	kg							*5450	5350			*3950	3900	7.28
4.5 m	kg							*6000	5200	*5650	3700	*3900	3350	7.98
3.0 m	kg					*8800	7550	*6900	5000	5550	3600	*4000	3050	8.35
1.5 m	kg					*10 650	7100	7600	4750	5450	3500	*4200	2950	8.44
Ground Line	kg			*6600	*6600	*11 650	6850	7400	4600	5350	3400	*4650	3000	8.26
-1.5 m	kg	*7050	*7050	*11 400	*11 400	11 600	6750	7350	4500	5350	3350	5050	3200	7.78
-3.0 m	kg	*12 100	*12 100	*15 600	13 100	*11 050	6800	7350	4550			6000	3750	6.94
-4.5 m	kg			*12 500	*12 500	*9000	7000					*6800	5200	5.60

*Indicates that the load is limited by hydraulic lifting capacity rather than tipping load. The above loads are in compliance with hydraulic excavator lift capacity standard ISO 10567:2007. They do not exceed 87% of hydraulic lifting capacity or 75% of tipping load. Weight of all lifting accessories must be deducted from the above lifting capacities. Lifting capacities are based on the machine standing on a firm, uniform supporting surface. The use of a work tool attachment point to handle/lift objects, could affect the machine lift performance.

Lift capacity stays within ± 5% for all available track shoes.

Always refer to the appropriate Operation and Maintenance Manual for specific product information.



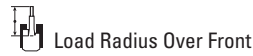











320E L VA Boom Lift Capacities



Boom – VA
Stick – R2.5B1

Counterweight – 3.55 mt
Shoes – 600 mm triple grouser















Bucket – None
Heavy Lift – On

		1.5 m		3.0 m		4.5 m		6.0 m		7.5 m				m
														
9.0 m	kg											*6700	*6700	4.10
7.5 m	kg					*7600	*7600	*5600	5200			*5500	5100	6.07
6.0 m	kg					*7600	*7600	*5200	*5200			*5050	3800	7.22
4.5 m	kg			*11 600	*11 600	*7450	*7450	*5050	5050	*5100	3550	*4950	3200	7.92
3.0 m	kg			*10 200	*10 200	*7300	7150	*5500	4750	*5350	3450	4650	2950	8.30
1.5 m	kg			*7450	*7450	*8250	6650	*6200	4500	5300	3300	4500	2850	8.39
Ground Line	kg	*10 200	*10 200	*6700	*6700	*10 700	6450	*7200	4350	5200	3250	4600	2900	8.20
-1.5 m	kg	*11 300	*11 300	*10 250	*10 250	*10 750	6450	7150	4300	5200	3250	5050	3150	7.72
-3.0 m	kg	*17 550	*17 550	*13 250	12 750	*8450	6550	*6300	4400			*5450	3800	6.76
-4.5 m	kg	*24 300	*24 300	*13 450	13 250							*9450	7800	4.14

Boom – VA
Stick – R2.9B1(HD)

Counterweight – 3.55 mt
Shoes – 600 mm triple grouser

Bucket – None
Heavy Lift – On

		1.5 m		3.0 m		4.5 m		6.0 m		7.5 m				m
														
9.0 m	kg					*5400	*5400					*5450	*5450	4.88
7.5 m	kg					*7400	*7400	*4600	*4600			*4650	4400	6.61
6.0 m	kg					*7500	*7500	*5250	5250	*4400	3550	*4350	3400	7.68
4.5 m	kg			*11 650	*11 650	*7300	*7300	*5250	5000	*4450	3500	*4250	2900	8.35
3.0 m	kg			*11 150	*11 150	*7100	*7100	*5200	4750	*4700	3400	4250	2650	8.70
1.5 m	kg			*6600	*6600	*7650	6650	*5850	4450	5250	3250	4150	2550	8.79
Ground Line	kg	*7350	*7350	*6000	*6000	*9950	6350	*6800	4250	5100	3150	4200	2600	8.61
-1.5 m	kg	*9050	*9050	*9300	*9300	11 150	6300	7050	4200	5100	3100	4550	2800	8.15
-3.0 m	kg	*14 300	*14 300	*12 950	12 450	*8950	6350	*6950	4250			*4850	3250	7.34
-4.5 m	kg	*22 350	*22 350	*13 200	12 850	*8400	6600					*7000	5200	5.35

*Indicates that the load is limited by hydraulic lifting capacity rather than tipping load. The above loads are in compliance with hydraulic excavator lift capacity standard ISO 10567:2007. They do not exceed 87% of hydraulic lifting capacity or 75% of tipping load. Weight of all lifting accessories must be deducted from the above lifting capacities. Lifting capacities are based on the machine standing on a firm, uniform supporting surface. VA-cylinder is flexible. The use of a work tool attachment point to handle/lift objects, could affect the machine lift performance.

Lift capacity stays within ± 5% for all available track shoes.

Always refer to the appropriate Operation and Maintenance Manual for specific product information.

320E Hydraulic Excavator Specifications

320E L Super Long Reach Boom Lift Capacities

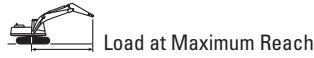

Boom – 8.85 m

















Counterweight – 4.6 mt















Bucket – None

Stick – 6.28 m Super Long Reach

Shoes – 790 mm triple grouser

Heavy Lift – On

		1.5 m		3.0 m		4.5 m		6.0 m		7.5 m		9.0 m				m
																
13.5 m	kg													*1400	*1400	12.32
12.0 m	kg													*1350	*1350	13.60
10.5 m	kg													*1300	*1300	14.62
9.0 m	kg													*1250	1150	15.42
7.5 m	kg													*1250	1050	16.05
6.0 m	kg													*1250	950	16.51
4.5 m	kg													*1250	850	16.83
3.0 m	kg			*2650	*2650	*5000	*5000	*3650	*3650	*2900	*2900	*2450	*2450	*1300	800	17.01
1.5 m	kg					*3750	*3750	*4350	4300	*3350	3250	*2750	2500	*1350	750	17.05
Ground Line	kg			*1150	*1150	*2650	*2650	*4950	3700	*3750	2850	*3050	2250	*1400	750	16.96
-1.5 m	kg	*1200	*1200	*1600	*1600	*2650	*2650	*4900	3350	*4050	2550	*3300	2050	1450	750	16.73
-3.0 m	kg	*1700	*1700	*2050	*2050	*2950	*2950	*4750	3150	*4300	2350	3450	1900	1500	750	16.37
-4.5 m	kg	*2150	*2150	*2550	*2550	*3400	*3400	*5050	3050	4300	2250	3350	1800	1550	800	15.85
-6.0 m	kg	*2650	*2650	*3100	*3100	*3950	*3950	*5600	3050	4300	2250	3350	1750	1650	850	15.16
-7.5 m	kg	*3200	*3200	*3700	*3700	*4650	*4650	*5450	3150	4300	2300	3350	1750	1850	950	14.29
-9.0 m	kg	*3800	*3800	*4400	*4400	*5500	5100	*5150	3300	*4150	2350	3400	1850	*2100	1150	13.18
-10.5 m	kg			*5200	*5200	*5900	5400	*4600	3500	*3750	2500	*3100	1950	*2150	1400	11.79
-12.0 m	kg					*4800	*4800	*3850	3750	*3100	2750	*2500	2150	*2150	1900	9.97

		10.5 m		12.0 m		13.5 m		15.0 m		16.5 m				m
														
13.5 m	kg											*1400	*1400	12.32
12.0 m	kg					*1450	*1450					*1350	*1350	13.60
10.5 m	kg					*1500	*1500					*1300	*1300	14.62
9.0 m	kg					*1550	*1550	*1550	1300			*1250	1150	15.42
7.5 m	kg					*1550	*1550	*1550	1250			*1250	1050	16.05
6.0 m	kg			*1700	*1700	*1650	1550	*1600	1200	*1250	950	*1250	950	16.51
4.5 m	kg	*2000	*2000	*1850	*1850	*1700	1500	*1650	1150	*1600	900	*1250	850	16.83
3.0 m	kg	*2200	*2200	*2000	1750	*1850	1400	*1700	1100	1600	850	*1300	800	17.01
1.5 m	kg	*2400	2000	*2150	1600	*1950	1300	*1800	1050	1550	850	*1350	750	17.05
Ground Line	kg	*2600	1800	*2250	1450	*2050	1200	1800	950	1500	800	*1400	750	16.96
-1.5 m	kg	*2750	1650	*2400	1350	2050	1100	1750	900	1500	750	1450	750	16.73
-3.0 m	kg	2800	1500	2350	1250	2000	1050	1700	850			1500	750	16.37
-4.5 m	kg	2750	1450	2300	1200	1950	1000	1700	850			1550	800	15.85
-6.0 m	kg	2700	1400	2250	1150	1950	1000	1700	850			1650	850	15.16
-7.5 m	kg	2700	1450	2250	1200	1950	1000					1850	950	14.29
-9.0 m	kg	2750	1500	2350	1250							*2100	1150	13.18
-10.5 m	kg	*2550	1600									*2150	1400	11.79
-12.0 m	kg											*2150	1900	9.97

*Indicates that the load is limited by hydraulic lifting capacity rather than tipping load. The above loads are in compliance with hydraulic excavator lift capacity standard ISO 10567:2007. They do not exceed 87% of hydraulic lifting capacity or 75% of tipping load. Weight of all lifting accessories must be deducted from the above lifting capacities. Lifting capacities are based on the machine standing on a firm, uniform supporting surface. The use of a work tool attachment point to handle/lift objects, could affect the machine lift performance.

Lift capacity stays within ± 5% for all available track shoes.

Always refer to the appropriate Operation and Maintenance Manual for specific product information.

320E LN Reach Boom Lift Capacities



Load Point Height



Load at Maximum Reach



Load Radius Over Front



Load Radius Over Side

Boom – 5.7 m

Stick – R2.5B1

Counterweight – 4.1 mt

Shoes – 500 mm triple grouser

Bucket – None

Heavy Lift – On

		3.0 m		4.5 m		6.0 m		7.5 m				m
7.5 m	kg									*5100	*5100	5.59
6.0 m	kg					*5750	4800			*4650	3850	6.83
4.5 m	kg			*7250	7150	*6200	4650	*5150	3250	*4550	3200	7.57
3.0 m	kg			*9150	6550	*7050	4400	5850	3150	*4700	2850	7.96
1.5 m	kg			*10 750	6100	*7850	4150	5700	3050	*5000	2750	8.05
Ground Line	kg			*11 450	5850	7800	4000	5600	2950	5250	2800	7.86
-1.5 m	kg	*11 900	10 750	*11 300	5800	7700	3950			5750	3050	7.35
-3.0 m	kg	*14 100	10 950	*10 250	5850	*7550	4000			*6750	3650	6.46
-4.5 m	kg			*7600	6150					*6550	5350	4.98

Boom – 5.7 m

Stick – R1.9CB2

Counterweight – 4.1 mt

Shoes – 500 mm triple grouser

Bucket – None

Heavy Lift – On

		3.0 m		4.5 m		6.0 m				m
7.5 m	kg							*6800	6750	4.74
6.0 m	kg					*6400	4600	*6400	4400	6.15
4.5 m	kg			*8000	6850	*6650	4500	*6350	3550	6.97
3.0 m	kg			*9800	6300	*7400	4250	5850	3100	7.39
1.5 m	kg			*11 100	5850	7850	4000	5650	2950	7.49
Ground Line	kg			*11 400	5700	7700	3900	5800	3050	7.28
-1.5 m	kg	*12 150	10 850	*10 850	5750	7700	3900	6500	3350	6.73
-3.0 m	kg	*12 300	11 000	*9400	5900			*7100	4250	5.74

*Indicates that the load is limited by hydraulic lifting capacity rather than tipping load. The above loads are in compliance with hydraulic excavator lift capacity standard ISO 10567:2007. They do not exceed 87% of hydraulic lifting capacity or 75% of tipping load. Weight of all lifting accessories must be deducted from the above lifting capacities. Lifting capacities are based on the machine standing on a firm, uniform supporting surface. The use of a work tool attachment point to handle/lift objects, could affect the machine lift performance.

Lift capacity stays within $\pm 5\%$ for all available track shoes.

Always refer to the appropriate Operation and Maintenance Manual for specific product information.

320E Hydraulic Excavator Specifications















320E LN Variable Angle Boom Lift Capacities



Boom – VA
Stick – R2.5B1 (HD)

Counterweight – 4.1 mt
Shoes – 500 mm triple grouser

Bucket – None
Heavy Lift – On

		1.5 m		3.0 m		4.5 m		6.0 m		7.5 m				m
														
9.0 m	kg											*6200	*6200	4.10
7.5 m	kg					*6850	*6850	*5200	4750			*5050	4650	6.07
6.0 m	kg					*6850	*6850	*4750	4750			*4650	3450	7.22
4.5 m	kg			*10 500	*10 500	*6700	*6700	*4650	4550	*4700	3200	*4550	2900	7.92
3.0 m	kg			*9650	*9650	*6500	6350	*5150	4250	*4900	3050	*4650	2600	8.30
1.5 m	kg			*7050	*7050	*7750	5850	*5850	4000	*5650	2950	4800	2500	8.39
Ground Line	kg	*9650	*9650	*6350	*6350	*10 100	5650	*6800	3850	5600	2850	4950	2550	8.20
-1.5 m	kg	*10 700	*10 700	*9700	*9700	*9750	5600	*7650	3800	*5550	2850	*5150	2750	7.72
-3.0 m	kg	*16 600	*16 600	*12 050	10 700	*7650	5750	*5700	3850			*4900	3350	6.76
-4.5 m	kg	*23 000	*23 000	*12 300	11 200							*8600	6850	4.14

*Indicates that the load is limited by hydraulic lifting capacity rather than tipping load. The above loads are in compliance with hydraulic excavator lift capacity standard ISO 10567:2007. They do not exceed 87% of hydraulic lifting capacity or 75% of tipping load. Weight of all lifting accessories must be deducted from the above lifting capacities. Lifting capacities are based on the machine standing on a firm, uniform supporting surface. VA-cylinder is flexible. The use of a work tool attachment point to handle/lift objects, could affect the machine lift performance.

Lift capacity stays within ± 5% for all available track shoes.

Always refer to the appropriate Operation and Maintenance Manual for specific product information.

320E L Work Tool Offering Guide*

Boom Type	Reach		VA Boom		
	Stick Size	R2.9B1 HD	R2.5B1 HD	R2.9B1 ES	R2.5B1 HD
Hydraulic Hammer		H115Es H120Es H130Es	H115Es H120Es H130Es	H115Es H120Es H130Es	H115Es H120Es H130Es
Multi-Processor		MP15**	MP15	MP15**^	MP15
Crusher		P315**	P315	P315**	P315
Pulverizer		P215	P215	P215	P215
Demolition and Sorting Grapple		G315B**	G315B G320B***#	G315B**	G315B G320B***#
Mobile Scrap and Demolition Shear		S320B** S325B##	S320B S325B##	S320B*** S325B##	S320B** S325B##
Compactor (Vibratory Plate)		CVP110	CVP110	CVP110	CVP110
Contractors' Grapple		G120B-G130B	G120B-G130B	G120B-G130B	G120B-G130B
Trash Grapple					
Thumbs					
Orange Peel Grapples					
Rakes					
Dedicated Quick Coupler					

These work tools are available for the 320E L.
Consult your Cat dealer for proper match.

*Matches are dependent on excavator configurations. Consult your Cat dealer for proper work tool match.

**Pin-on or CW coupler.

***Pin-on only.

#Over the front only.

##Boom mount.

^PP jaws pin-on only.

320E Hydraulic Excavator Specifications

320E LN Work Tool Offering Guide*

Boom Type	Reach HD		VA Boom
	R2.5B1 ES	R1.9CB2 HD	R2.5B1 ES
Hydraulic Hammer	H115Es H120Es H130Es	H120Es H130Es H140Ds**#	H115Es H120Es H130Es***
Multi-Processor	MP15 CC Jaw** MP15 CR Jaw** MP15 PP Jaw**# MP15 PS Jaw** MP15 S Jaw**	MP15 CC Jaw** MP15 CR Jaw** MP15 PP Jaw** MP15 PS Jaw** MP15 S Jaw**	MP15 CC Jaw*** MP15 CR Jaw*** MP15 S Jaw***
Crusher	P315##	P315**	P315***
Pulverizer	P215	P215	P215**
Demolition and Sorting Grapple	G315B**		
Mobile Scrap and Demolition Shear	S320B***# S325B^	S320B** S325B^	S325B^
Compactor (Vibratory Plate)	CVP110	CVP110	CVP110
Contractors' Grapple	G120B-G130B	G120B-G130B	G120B-G130B
Trash Grapple			
Thumbs			
Orange Peel Grapples			
Rakes			
Dedicated Quick Coupler			

These work tools are available for the 320E LN.
Consult your Cat dealer for proper match.

*Matches are dependent on excavator configurations. Consult your Cat dealer for proper work tool match.

**Pin-on or CW coupler.

***Pin-on only.

#Over the front only with CW coupler.

##Over the front only with the CL coupler.

^Boom mount.

320E L Bucket Specifications and Compatibility

	Linkage	Width	Capacity	Weight	Fill	Reach Boom		VA Boom		Super Long Reach
		mm	m ³	kg	%	R2.9 HD	R2.5 HD	R2.9 ES	R2.5 HD	6.28 m
Without Quick Coupler										
General Duty (GD)	B	600	0.46	549	100%	●	●	●	●	
	B	750	0.64	620	100%	●	●	●	●	
	B	900	0.81	666	100%	●	●	●	●	
	B	1200	1.19	800	100%	⊙	●	⊙	⊙	
	B	1300	1.30	832	100%	⊙	⊙	⊖	⊙	
	B	1400	1.43	867	100%	⊖	⊙	○	⊖	
Heavy Duty (HD)	B	1050	1.00	879	100%	●	●	●	●	
	B	1200	1.19	906	100%	⊙	●	⊖	⊙	
	B	1200	1.19	917	100%	⊙	●	⊖	⊙	
	B	1300	1.30	960	100%	⊖	⊙	⊖	⊖	
Severe Duty (SD)	B	1200	1.19	1000	90%	⊙	●	⊙	●	
Super Long Reach (SLR)	SLR	813	0.46	341	100%					○
	SLR	1143	0.61	289	100%					◇
Maximum load pin-on (payload + bucket)					kg	3115	3355	2895	3150	915
With Quick Coupler (CW40, CW40s)										
General Duty (GD)	B	600	0.46	502	100%	●	●	●	●	
	B	750	0.64	587	100%	●	●	●	●	
	B	900	0.81	653	100%	●	●	●	●	
	B	1200	1.19	767	100%	⊙	⊙	⊖	⊙	
	B	1300	1.30	798	100%	⊖	⊙	○	⊖	
	B	1400	1.43	834	100%	○	⊖	○	⊖	
Heavy Duty (HD)	B	600	0.46	584	100%	●	●	●	●	
	B	1200	1.19	873	100%	⊖	⊙	⊖	⊖	
	B	1300	1.30	927	100%	⊖	⊖	○	⊖	
Severe Duty (SD)	B	1200	1.19	984	90%	⊙	⊙	⊖	⊙	
Maximum load with coupler (payload + bucket)					kg	2863	3103	2643	2898	

Maximum Material Density:

- 2100 kg/m³
- ⊙ 1800 kg/m³
- ⊖ 1500 kg/m³
- 1200 kg/m³
- ◇ 900 kg/m³

The above loads are in compliance with hydraulic excavator standard EN474, they do not exceed 87% of hydraulic lifting capacity or 75% of tipping capacity with front linkage fully extended at ground line with bucket curled.

Capacity based on ISO 7451.

Bucket weight with General Duty tips.

Caterpillar recommends using appropriate work tools to maximize the value customers receive from our products. Use of work tools, including buckets, which are outside of Caterpillar's recommendations or specifications for weight, dimensions, flows, pressures, etc. may result in less-than-optimal performance, including but not limited to reductions in production, stability, reliability, and component durability. Improper use of a work tool resulting in sweeping, prying, twisting and/or catching of heavy loads will reduce the life of the boom and stick.

320E Hydraulic Excavator Specifications

320E LN Bucket Specifications and Compatibility

	Linkage	Width	Capacity	Weight	Fill	Reach Boom (HD)		VA Boom
		mm	m ³	kg	%	R2.5 ES	R1.9CB HD	R2.5 ES
Without Quick Coupler								
General Duty (GD)	B	600	0.46	549	100%	●		●
	B	750	0.64	620	100%	●		●
	B	900	0.81	666	100%	●		●
	B	1200	1.19	800	100%	⊖		⊖
	B	1300	1.30	832	100%	⊖		⊖
	B	1400	1.43	867	100%	○		○
Heavy Duty (HD)	B	1050	1.00	879	100%	⊙		⊙
	B	1200	1.19	906	100%	⊖		⊖
	B	1200	1.19	917	100%	⊖		⊖
	B	1300	1.30	960	100%	○		○
Severe Duty (SD)	B	1200	1.19	1000	90%	⊖		⊖
Maximum load pin-on (payload + bucket)					kg	2810	3110	2720
With Quick Coupler (CW40, CW40s)								
General Duty (GD)	B	600	0.46	502	100%	●		●
	B	750	0.64	587	100%	●		●
	B	900	0.81	653	100%	●		●
	B	1200	1.19	767	100%	⊖		⊖
	B	1300	1.30	798	100%	○		○
	B	1400	1.43	834	100%	○		○
Heavy Duty (HD)	B	600	0.46	584	100%	●		●
	B	1200	1.19	873	100%	○		○
	B	1300	1.30	927	100%	○		○
Severe Duty (SD)	B	1200	1.19	984	90%	⊖		○
Maximum load with coupler (payload + bucket)					kg	2558		2468

The above loads are in compliance with hydraulic excavator standard EN474, they do not exceed 87% of hydraulic lifting capacity or 75% of tipping capacity with front linkage fully extended at ground line with bucket curled.

Capacity based on ISO 7451.

Bucket weight with General Duty tips.

Maximum Material Density:

- 2100 kg/m³
- ⊙ 1800 kg/m³
- ⊖ 1500 kg/m³
- 1200 kg/m³

Caterpillar recommends using appropriate work tools to maximize the value customers receive from our products. Use of work tools, including buckets, which are outside of Caterpillar's recommendations or specifications for weight, dimensions, flows, pressures, etc. may result in less-than-optimal performance, including but not limited to reductions in production, stability, reliability, and component durability. Improper use of a work tool resulting in sweeping, prying, twisting and/or catching of heavy loads will reduce the life of the boom and stick.

Standard equipment may vary. Consult your Cat dealer for details.

ENGINE

- C6.6 diesel engine
- Biodiesel capable
- European Union Stage IIIB compliant
- 2300 m altitude capability
- Electric priming pump (lifting pump)
- Automatic engine speed control
- Economy and high power modes
- Two-speed travel
- Side-by-side cooling system (tilt-up ATAAC, swing-out A/C condenser)
- Radial seal air filter
- Primary filter with water separator and water separator indicator switch
- Standard battery, -18° C
- Screen fuel filter in fuel lines
- Primary fuel filter
- Secondary fuel filter

HYDRAULIC SYSTEM

- Regeneration circuit for boom and stick
- Reverse swing dampening valve
- Automatic swing parking brake
- High-performance hydraulic return filter
- Capability of installing HP stackable valve and medium and QC valve
- Capability of installing additional auxiliary pump and circuit
- Capability of installing boom lowering control device and stick lowering check valve
- Capability of installing Cat Bio hydraulic oil
- Quick drains, engine and hydraulic oil (QuickEvac™)

CAB

- Pressurized operator station with positive filtration
- Mirror package
- Sliding upper door window (left-hand cab door)
- Glass-breaking safety hammer
- Removable lower windshield with in cab storage bracket
- Coat hook
- Beverage holder
- Literature holder
- Two 12V stereo speakers
- Storage shelf suitable for lunch or toolbox
- Color LCD display with warning, filter/fluid change, and working hour information
- Adjustable armrest
- Height adjustable joystick consoles
- Neutral lever (lock out) for all controls
- Travel control pedals with removable hand levers
- Capability of installing two additional pedals
- Two power outlets, 10 amp (total)
- Laminated glass front upper window and tempered other windows
- Sunscreen
- Windshield wiper, lower with washer

UNDERCARRIAGE

- Grease Lubricated Track GLT2, resin seal
- Towing eye on base frame

ELECTRICAL

- 80 amp alternator
- Circuit breaker
- Capability to electrically connect a beacon

LIGHTS

- Boom light with time delay
- Exterior lights integrated into storage box

SECURITY

- Cat one key security system
- Door locks
- Cap locks on fuel and hydraulic tanks
- Lockable external tool/storage box
- Signaling/warning horn
- Secondary engine shutoff switch
- Openable skylight for emergency exit
- Rearview camera

TECHNOLOGY

- Product Link

320E Optional Equipment

Optional equipment may vary. Consult your Cat dealer for details.

ENGINE

Electric refueling pump with auto shut off
Cold weather battery, -32° C
Radiator screen

HYDRAULIC SYSTEM

Additional circuit
Boom and stick lines
High-pressure line
Medium-pressure line
Cat quick coupler line –
high- and medium-pressure capable
Electronic Control device,
1/2P, one-way circuit
Electronic Control device (Common),
1/2P, common circuit

CAB

Seat, high-back air suspension with heater
Seat, high-back mechanical suspension
Air pre-filter
Left foot switch
Straight travel pedal
Rain protector

UNDERCARRIAGE

500 mm triple grouser shoes (LN)
600 mm triple grouser shoes
700 mm triple grouser shoes
790 mm triple grouser shoes
Full length track guiding guard
Center track guiding guard
Segmented (2 piece) track guiding guard

FRONT LINKAGE

Quick coupler
Bucket linkage, B1 family with
and without lifting eye
Bucket linkage, CB2 family
with lifting eye (LN)
Reach Boom 5.7 m
2.9 m Heavy Duty and Extreme
Service sticks
2.5 m Heavy Duty and Extreme
Service sticks
1.9 m Heavy Duty stick
VA boom
2.9 m Heavy Duty and Extreme
Service sticks
2.5 m Heavy Duty and Extreme
Service sticks
Super Long Reach Boom and Stick

LIGHTS

Working lights, cab mounted with time delay
HID lights, cab mounted with time delay

SECURITY

FOGS, bolt-on
Travel alarm

TECHNOLOGY

Cat Grade Control Depth and Slope

COUNTERWEIGHT

L: 3.55 tons
LN: 4.1 tons
SLR: 4.6 tons

320E Hydraulic Excavator

For more complete information on Cat products, dealer services, and industry solutions, visit us on the web at www.cat.com

© 2012 Caterpillar Inc.
All rights reserved

Materials and specifications are subject to change without notice. Featured machines in photos may include additional equipment. See your Cat dealer for available options.

CAT, CATERPILLAR, SAFETY.CAT.COM, their respective logos, "Caterpillar Yellow" and the "Power Edge" trade dress, as well as corporate and product identity used herein, are trademarks of Caterpillar and may not be used without permission.

AEHQ6583-03 (11-2012)
Replaces AEHQ6583-02
(EU)

